

Shinebot W400

Floor Washing Robot

User Guide



For more details, please
visit www.iliferobot.com

ILIFE

Thank you for choosing Shinebot W400 Floor Washing Robot!
You've joined millions of people to get cleaning done robotically.

This user manual helps you to keep your robot performing at its best. Please take a few moments to read through it.

You may also connect with us on Facebook and Twitter to enjoy exclusive benefits:

- Get model-specific customer support, including Q&A, maintenance tips, demo videos, live chat and more;
- Get the most recent product updates including new product launches, exclusive discounts and special promotions.

You may find us on:

Facebook: <https://www.facebook.com/iliferobotics>

Twitter: <https://twitter.com/iliferobotics>

If you have any questions, please contact our customer service for assistance or visit www.iliferobot.com for more information.

Enjoy automated home cleaning performed by Shinebot W400.

ILIFE Innovation

ILIFE Customer Service

Customer Service Number:

1-800-631-9676 (Toll free for USA & Canada)

Mon-Fri: 9:00 a.m. - 18:00 p.m.

+86-75521005927 (Outside USA & Canada)

Mon-Fri: 9:00 a.m. - 18:00 p.m. Sat: 9:00 a.m. - 12:00 p.m. (GMT+8)

Email: support@iliferobot.com

Contents

1. Important Safety Instructions	1
2. Important Tips	3
2.1 How to start	3
2.2 How to perform the best	3
3. In the Box	5
4. Product Anatomy	6
4.1 Main body	6
4.2 Display panel	6
4.3 Major components	7
4.4 Remote control	9
4.5 Charging dock	9
5. Installation	10
5.1 Install the charging dock	10
5.2 Install the main brush	11
5.3 Install the water tank	11
6. Start Cleaning	13
6.1 Place the robot	13
6.2 Select cleaning mode	13

Contents

7. Maintenance	16
7.1 Clean the dirty water tank	16
7.2 Clean the main brush	17
7.3 Clean the filter	18
7.4 Clean the water tank openings	18
7.5 Clean the nose wheel	19
8. Troubleshooting	20
9. Product specifications	21

Important Safety Instructions

- * When using electrical appliance, basic precautions should always be followed, including the following:
- * **Read all instructions before using this appliance.**



WARNING - To reduce the risk of fire, electric shock, or injury.

- Do not leave appliance when plugged in. Unplug from outlet when not in use and before servicing.
- Do not use outdoors.
- Do not allow device to be used as a toy. Close attention is necessary when used by or near children.
- Use only as described in this manual. Use only manufacturer's recommended attachments.
- Do not use with damaged power cord or plug. If appliance is not working as it should, or it has been dropped, damaged, left outdoors, or dropped into water, return it to a service center.
- Do not pull or carry by power cord, use power cord as a handle, close a door on power cord, or pull power cord around sharp edges or corners. Do not run appliance over power cord. Keep power cord away from heated surfaces.
- Do not unplug by pulling on power cord. To unplug, grasp the plug, not the power cord.
- Do not handle plug or appliance with wet hands.
- Do not put any objects into openings. Keep free of dust, lint, hair and anything that may reduce air flow.
- Keep hair, loose clothing, fingers, and all parts of body away from openings and moving parts.
- Turn off all controls before unplugging.
- Do not use the robot to wash flammable or combustible liquids, such as gasoline, or use in areas where they may be present.

Important Safety Instructions

! CAUTION- To reduce the risk of injury from moving parts, unplug before servicing.

- Do not allow robot to clean anything that is burning or smoking, such as cigarettes, matches, or hot ashes.
- Do not use without water tank in place.
- Always insert batteries correctly with regard to polarity (+ and -) marked on the battery and the product.
- Exhausted batteries should be immediately removed from product and properly disposed of.

Intended use

- This product is intended for household use only. It is not intended for commercial use.
- This product is intended to work in environment between 10°C and 50°C.

Tips and tricks

- Stop the appliance promptly if error occurs during cleaning. Before using the appliance, remove all power cords and small objects from on the floor.
- Roll up carpet tassels and make sure that curtains and tablecloths are not in contact with the floor.
- If there are any raised floors such as steps or stairs, test if the appliance can detect the height difference to prevent it from falling.
- Do not allow hair, clothes or fingers near openings or mechanical parts of the appliance.
- Do not put any objects in the main brush holder. To ensure smooth rotation of the main brush, remove dust, batting and any hair from around it.



Important Tips



Shinebot contains electronic parts. DO NOT immerse the robot's main body in water.

How to start

- **Turn on/off**

To turn the robot on, press  for 1s. To turn it off, press  for 3s. Release the button after a sound alert.

- The robot will automatically shutdown if no command is received within 3 minutes.

- **Pause/Resume**

To pause the robot, press  while it's cleaning. Press  again to resume the cleaning cycle.

- **Clean**

Install the main brush before use. Fill the clean water tank with clean water and DO NOT add any detergents.

How to perform the best

- Fill up the clean water tank before each use for better performance.
- Choose the Spot mode for areas with stubborn stains.
- Empty the dirty water tank after each use, and clean the water tank outlets and inlets regularly.
- Remove the main brush and rinse with water once a week.
- Clean both vents and remove the dust and debris regularly.
- The robot is skilled at cleaning up different types of stains, like milk, ketchup, coffee and footprints.



Important Tips

- The robot works on a variety of hard floor surfaces, such as porcelain tiles, vinyl flooring, and laminated floors.

- The robot performs well on tile floor with small gaps.



- The robot does not work properly on tile floors with gaps wider than 10mm.

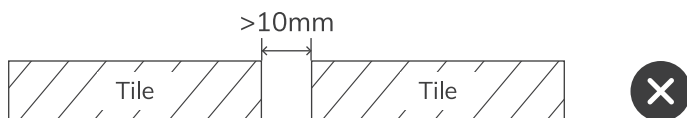

- The robot does not work properly on tile floors if the height difference between tiles is higher than 3mm.



- The robot does not work properly on uneven tile floors (more than 2mm in height).

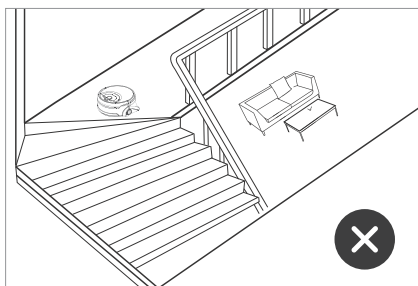

- Don't use the robot on the upper floor if there is a risk of it falling down.

- Don't use the robot on stairs to reduce the risk of it falling down.

In the Box



Robot main body
(include a main brush)



Charging dock



Adapter



Main brush



Cleaning tool



Filter



Remote control

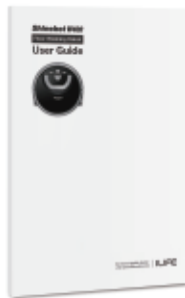

User guide



AAA battery (X2)



Main body

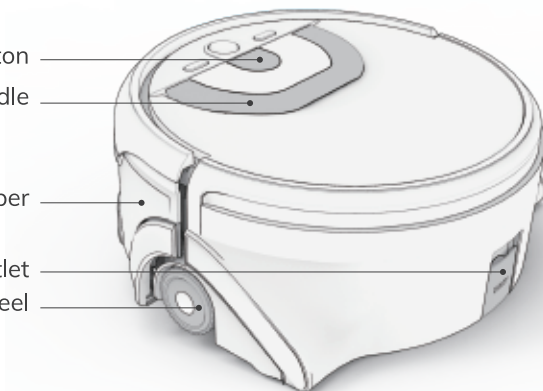

- Water tank release button
- Handle
- Bumper
- Dirty water outlet
- Side wheel

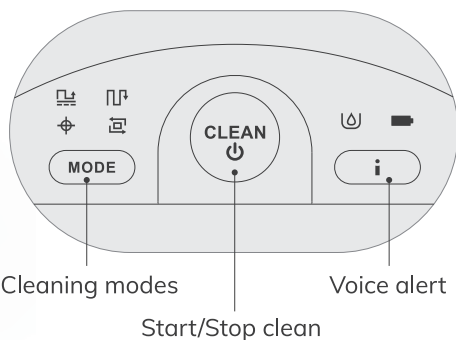



Display panel



 : Area mode
 : Path mode

 : Spot mode
 : Edge mode

 : Water tank alert
 : Battery level

Product Anatomy

Host machine

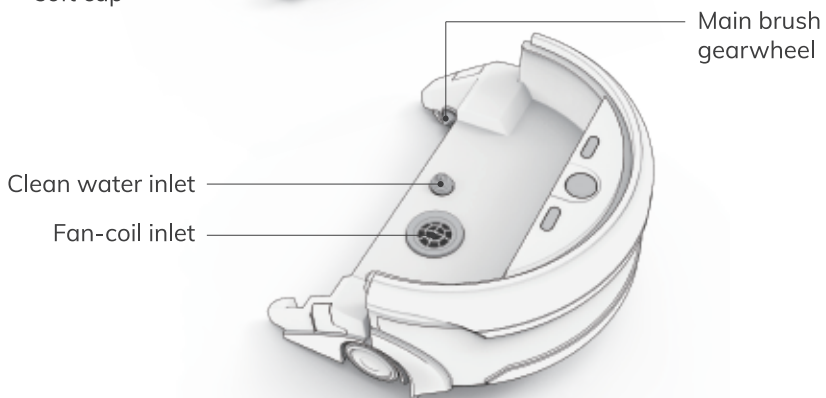
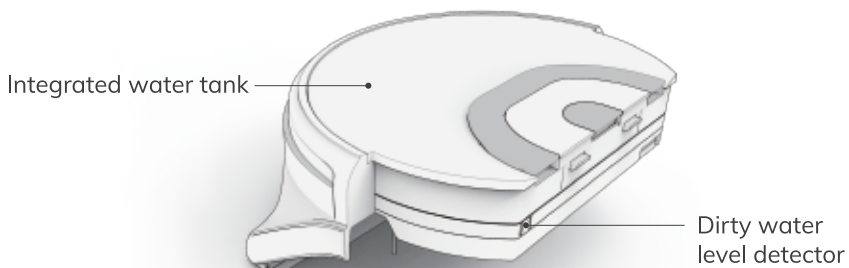

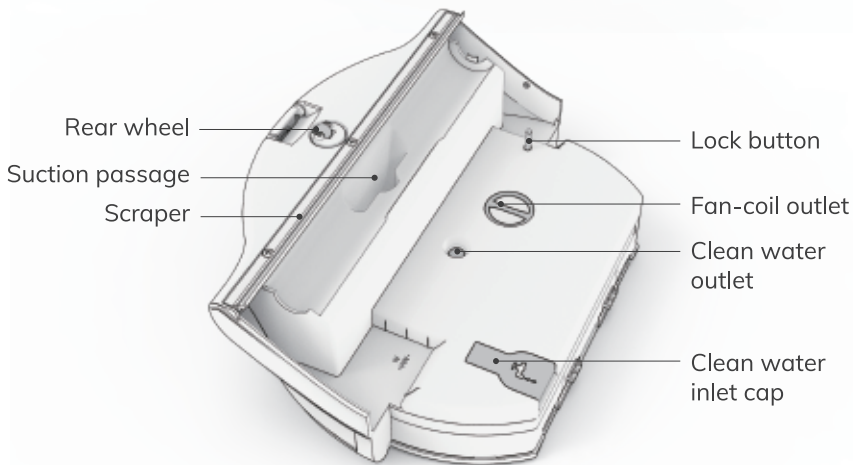
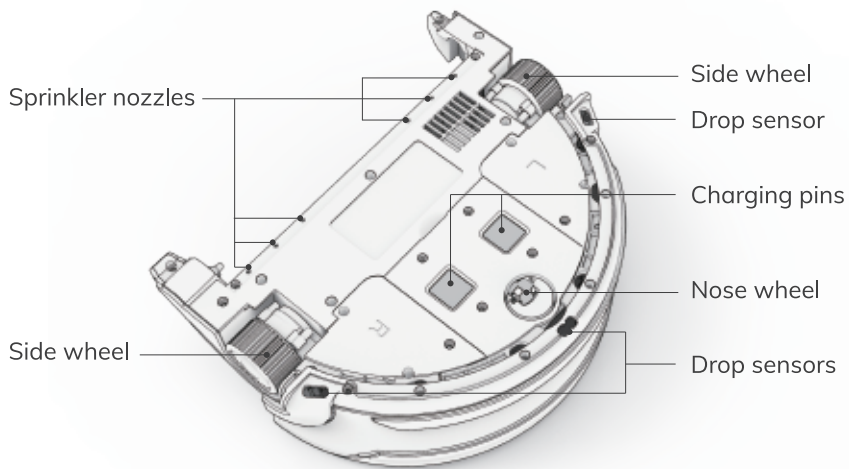

Product Anatomy

Remote control

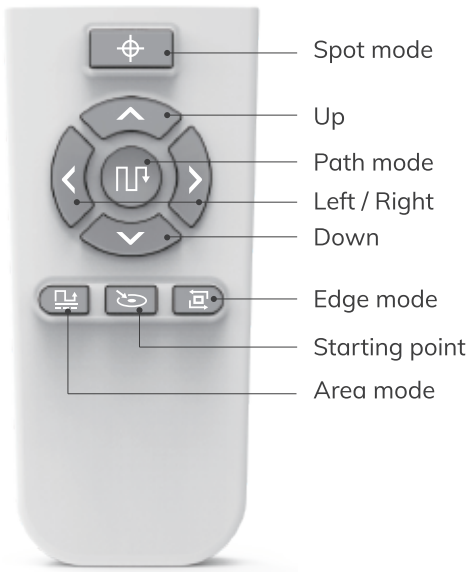

* Up/Down/Left/Right Direction can only be changed when the robot is on standby. Long press **▲** to activate the robot and move it forward. The robot will follow the direction that the remote control points at and start cleaning.

Charging dock

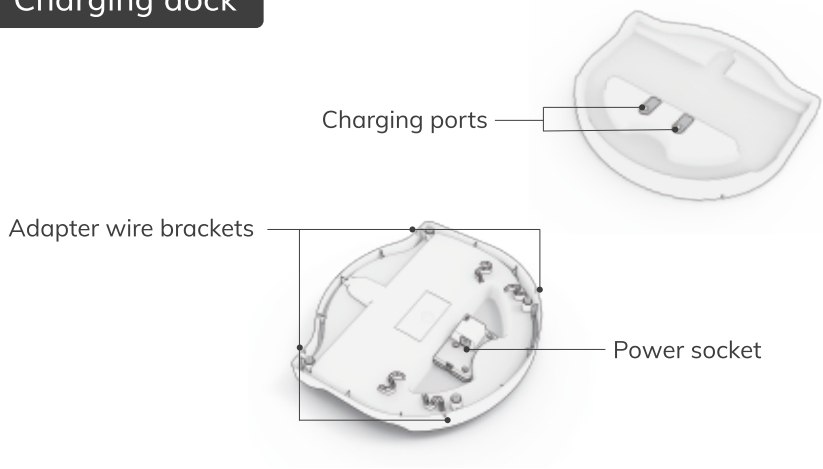

Install the charging dock

Shinebot W400 is not a self-charging robot. Please take it to the dock manually for recharging after each use.

Step 1



1 Turn the charging dock upside down.

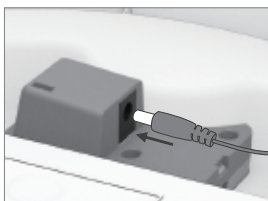

2 Plug in the power cord.



3 Secure wires around the cable channel.

• Step 2

Put the charging dock somewhere level, dry and safe, and manually take the robot back to the charging dock to recharge.

Voice alert: Charging will start soon.



1 Put charging dock and the robot in right direction.



2 Take the robot back to charging dock.



Note: Do not put the main brush on the metal chips of the charging dock. The brushes may have residual moisture and cause damage.

Battery condition

- Please check  icon on the display panel if needed, and recharge if it goes low.

	Green light	Orange light	Red light
Working time	>30 mins	<30 mins	Recharge immediately

Installation

Install the main brush

- It's recommended to properly dampen the main brush before installation for better cleaning performance.



- 1 Insert the recessed end of the main brush into the gearwheel.
- 2 Press down on the capped end into the other end of the main body.



Install the water tank

Step1. Fill the water tank

- 1 Press down on the water tank release button, pull the handle up to detach the tank.
- 2 Turn the integrated water tank upside down.
- 3 Open the clean water tank cap and fill up the tank with clean water.



- Note: 1. Do not use distilled or purified water.
2. Do not add any detergents.

Step2. Install the water tank

- 1 Align the bottom of the integrated water tank with the main body and push forward.

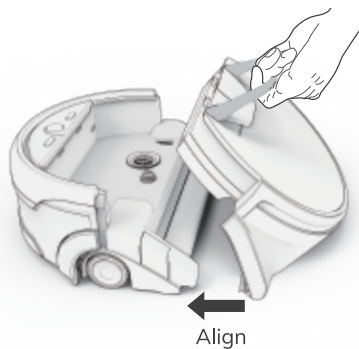

- 2 Align the ends and move the water tank to insert it into the main body.

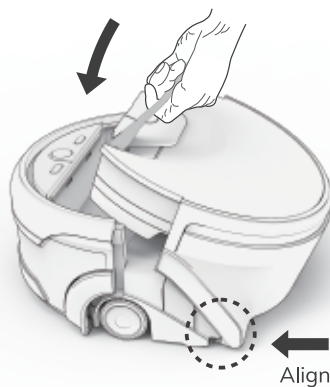

- 3 Press down, and a "click" will be heard if installed properly.



Start Cleaning

Place the robot

- Take the robot out of the charging dock to the cleaning starting spot, and place the robot at least 1.6 ft away from the wall.

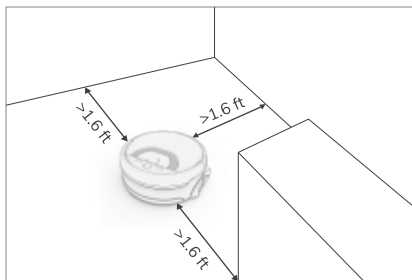

Select cleaning mode

- The robot has 4 cleaning modes. Choose the mode you need by pressing the MODE button on the display panel or corresponding buttons on the remote control.
- Press  button to start cleaning.

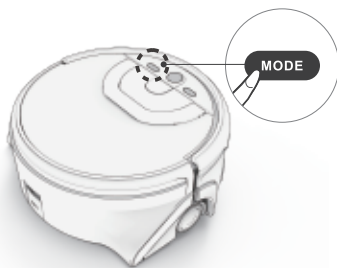

or

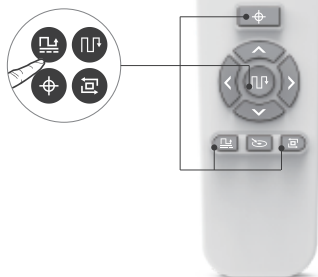

A Tap the MODE button to switch cleaning modes.

B Press the button on the remote control to switch modes directly.



The robot will continue to clean using the last used cleaning mode if no new command is received.

Area mode

- The robot cleans only the area ahead of its starting point within 270 sq.ft. This mode is intended to avoid the areas you don't want cleaned.

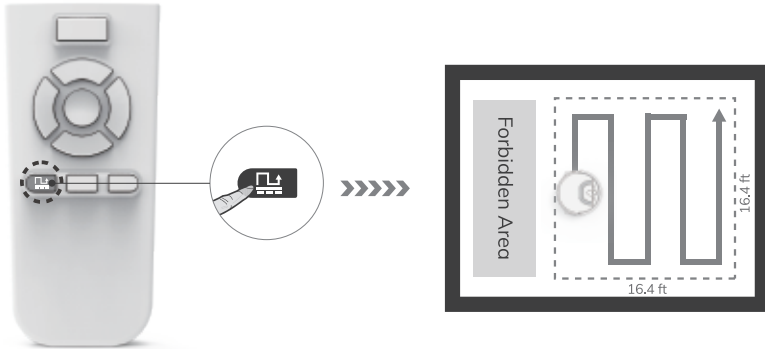

Path mode

- For large space cleaning. The robot cleans in a methodical path from the starting spot. After the cleaning cycle, the robot will return to the starting spot.

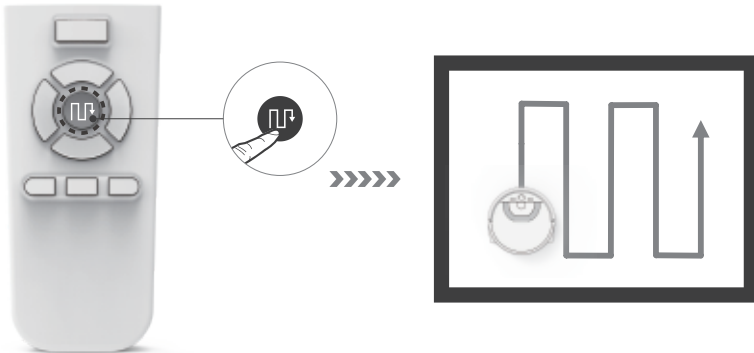

Start Cleaning

Spot mode

- The robot automatically increases suction power and water flow to clean stubborn stains. It cleans at a square spiral route from the starting point, and it will take the same route back to the starting spot after two rounds of cleaning.

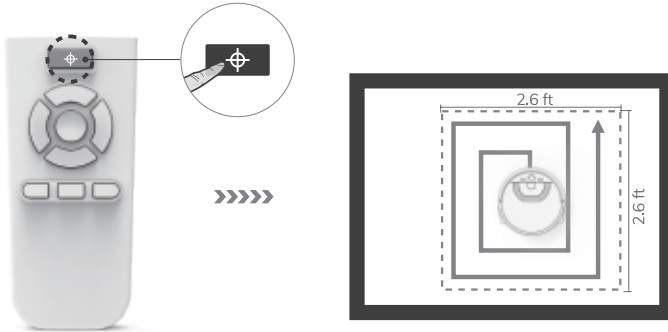

Edge mode

- On the Edge mode, the robot will automatically detect and clean along edges and around corners.

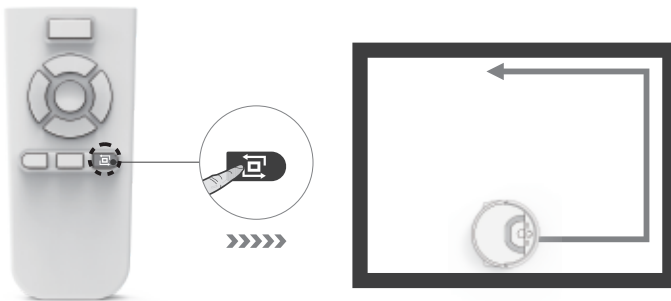

Note: Before starting Edge mode, put the robot near the walls and remove the obstacles nearby, such as chairs, tables, etc.

- To keep the robot running at peak performance, you are advised to perform the following maintenance regularly:

Component	Maintain	Replace
Water tank	After each use	/
Main brush	Once per week	3-5 months
Filter	Once per week	3-5 months
Suction passage	Once per week	/
Fan-coil outlet	Once per week	/
Nose Wheel	Once per month	/

Clean the dirty water tank

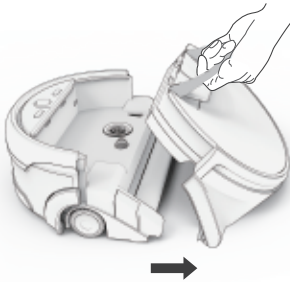

1 Detach the integrated water tank.



2 Open the cap and empty the waste.

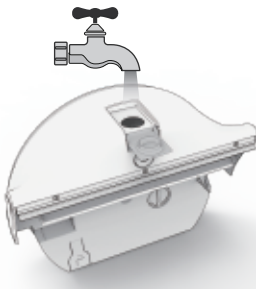

3 Fill the dirty water tank with clean water. Close the cap and shake.



4 Open the cap again and empty the tank.

Maintenance

Clean the main brush

- Remove the integrated water tank and take out the main brush, then rinse with clean water.

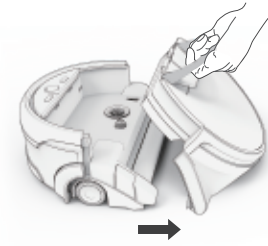

1 Detach the integrated water tank.

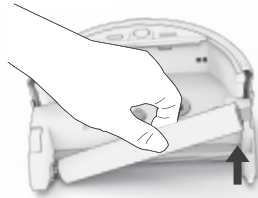

2 Remove the main brush from the robot body.



3 Remove all the debris on the main brush.



4 Rinse the main brush with clean water, and air dry it before reinstallation.

Clean the filter

- Remove the filter from the water tank and rinse with water.



Clean the water tank openings

- After removing the filter, press the water tank lock button to open the fan-coil outlet. To maintain the water tank's proper functioning, clean both openings of the fan-coil outlet and remove dust and debris.

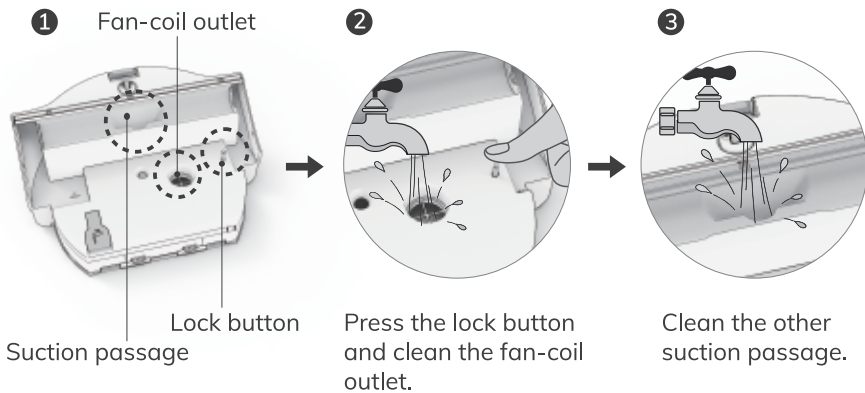

Maintenance

- To keep the tanks tightly sealed, clean the inlet and outlet, and the caps of both tanks regularly.

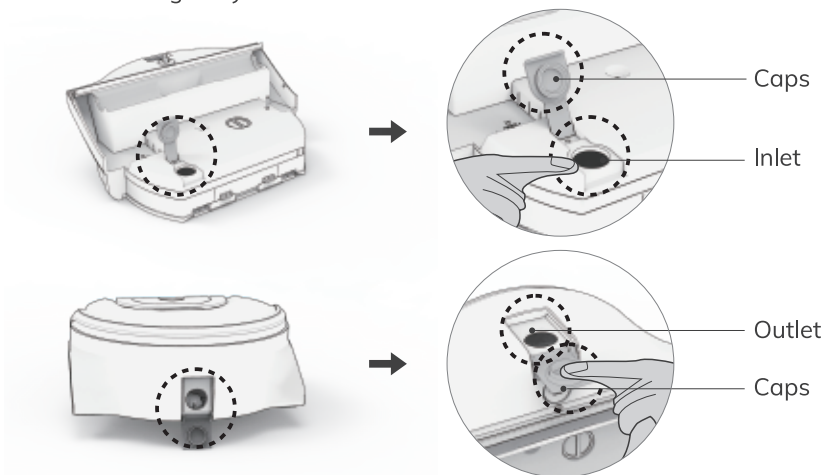

Clean the nose wheel

- Turn the robot upside down and check if the castors can rotate smoothly. Remove the nose wheel by pulling it out vertically. Check if there is any hair or debris stuck on it.

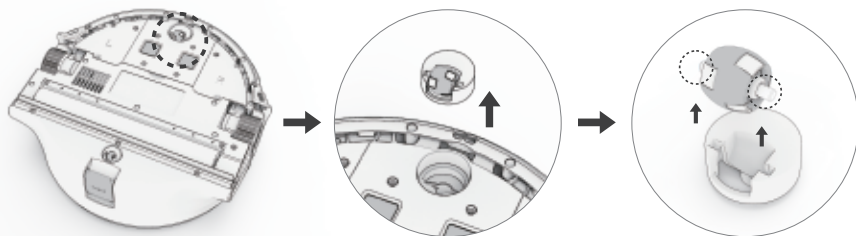

1 Turn the robot upside down.





2 Pull the nose wheel out vertically.

3 Check if there is any hair or debris stuck on it.



Note: After maintenance, reinstall all components and place the robot on the charging dock. Always store the robot in a safe environment.

• Voice Alerts

Alert	Light signal	Possible cause	Solution	
Please check and install water tank	 : Red CLEAN : Red  : Orange	Water tank isn't installed or properly installed.	Ensure the water tank is installed properly.	
Please check clean water tank		Water tank is empty or clogged.	<ul style="list-style-type: none"> • Fill with clean water • Check the clean water inlet. 	
Please check dirty water tank		Dirty water tank is full.	Empty the dirty water tank.	
Please put robot to open area	CLEAN : Red  : Orange	Robot is stuck in a narrow space.	Put the robot in an open area and start cleaning again.	
Please check main brush		Main brush is jammed.	<ul style="list-style-type: none"> • Check if the main brush is jammed because of an object. • Clean both ends of the main brush. 	
Please clean nose wheel		Nose wheel is stuck.	Check if the wheel is jammed by debris or hair. Remove the wheel and clean it.	
Please clean drop sensors		Drop sensors are contaminated.	Check and clean the drop sensors.	
Please put robot back to ground		Robot isn't on a flat surface.	Put the robot on a flat floor.	
Low battery		 : Red	Battery is low.	Recharge the robot.

Product Specifications

Description	Specification
Battery	Li-ion
Adaptor	Input: AC 100-240V~50/60HZ
	Output: DC 19V 0.6A
Clean water tank capacity	0.85L
Dirty water tank capacity	0.9L
Charging time	250-300 mins
Working time	Up to 80 mins
Main body size	282 x 292 x 118 mm
Charging dock size	289 x 315 x 49 mm
Main body + Charging dock size	289 x 315 x 168 mm

ILIFE Customer Service

Customer Service Number:

1-800-631-9676

(Toll free for USA & Canada) Mon-Fri: 9:00 a.m. - 18:00 p.m.

+86-75521005927

(Outside USA & Canada) Mon-Fri: 9:00 a.m. - 18:00 p.m. Sat: 9:00 a.m.-12:00 p.m. (GMT+8)

Email: support@iliferobot.com